

Environmental

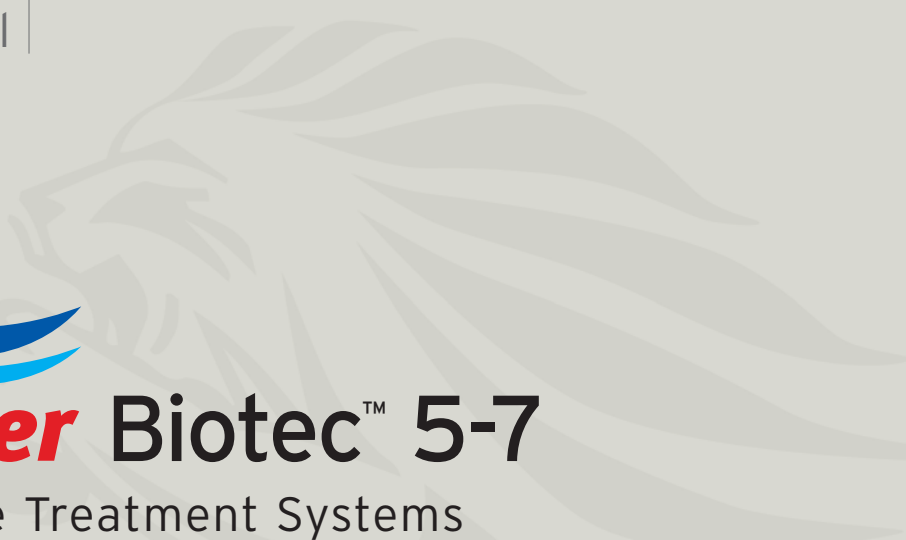

Klargester Biotec™ 5-7

Package Sewage Treatment Systems
for Residential, Business & Leisure Applications



Sustainable, Reliable, Affordable



Kingspan®

Klargester Biotec™ 5-7

Introducing the new Biotec™ 5-7 range

Heightened environmental standards, more stringent controls, new European guidelines and the introduction of new Building Regulations have placed greater importance than ever before on the need to install correctly sized and specified sewage treatment plants.

Such systems have to deliver high performance, but also be capable of supporting future demand, not just current level of use.

The requirement for a more flexible plant has led to the development of the **Biotec™ 5-7** – a whole new range of sewage treatment plant to meet the demands of today's consumer.

We have drawn on over 40 years of expertise in treatment plant technology in order to meet our own strict criteria in the development of the **Biotec™ 5-7** range:

- High rate performance across a range of influent and effluent qualities
- Low head loss
- Minimal footprint area
- Single piece tank for rapid installation and reduced costs
- Variable invert options
- Minimal visual impact (below ground)
- Low running costs
- May be installed in trafficked areas (subject to loading)
- Compliant with EN-12255
- Designed for applications selected in compliance with British Water Code of Practice Flows and Loads
- Low maintenance
- Alarm protected

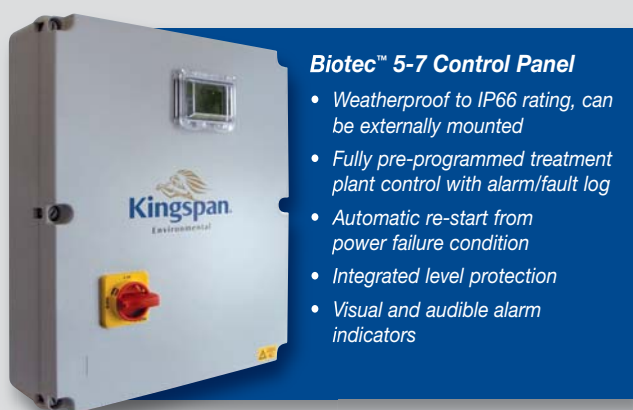

Process Design

The **Biotec™ 5-7** range of sewage treatment plants employ a plug flow combination of aerobic processes in a fluidised bed arrangement. This operates in conjunction with an advanced system of air diffusers and selected media to deliver optimum levels of purification.

This process takes place in three distinct stages:-

1. Primary Settlement

This is the initial stage of treatment and simply involves the retention of coarse solids present in raw sewage and wastewater for subsequent gradual breakdown. The **Biotec™ 5-7** range features two chambers to ensure efficient operation with a flow balancing facility.

2. Biological Treatment

Substantial BOD reduction takes place here, where the carbonaceous pollutants are removed by presenting the sewage to the micro-organisms in the presence of oxygen. The treatment is achieved by high efficiency air diffusers continually pumping oxygen through the biological media and fluidised effluent. **Biotec™** models utilise two aerobic treatment chambers for standard performance applications.

3. Settlement

A natural by-product of biological treatment is humus sludge and this is separated for further treatment. The treated effluent is discharged via the outlet. In standard configuration the **Biotec™ 5-7** range will deliver a treatment better than 20mg/l BOD, 30mg/l S.S., with ammonia levels better than 20mg/l depending on the application.

Flow Management

The **Biotec™ 5-7** range design incorporates flow management in order to both stabilise influent volume variations and to minimise hydraulic impact on the final settlement process. Such control ensures that final effluent remains at a consistently high quality.

Options

- Choice of inverts (from 0.5 to 2.0m)
- Standby blowers
- Alarm systems
- Sample chambers
- Pumping stations
- Extension shafts (to 2.0m maximum standard invert)

Klargester Biotec™ 7

Service & Maintenance

Biotec's individual chambers have large dedicated manholes to allow quick and easy maintenance access. Servicing is also simplified as **Biotec's** flow control makes it unnecessary to empty the biozones, as is the case with other designs of treatment plant.

As a result there is no loss of plant performance during periodic maintenance. The biozones immediately resume operation following servicing, whilst the influent level is restored.

Specialist Advice

Delivering high quality effluent requires careful evaluation of the various parameters affecting each scheme. Relatively minor changes may result in the loss of one or more of the required effluent qualities.

Klargester's team of technical specialists assess each site's demands and application and tailor a technical specification to meet the consent requirements.

Plant sizing is not only calculated on current demand but also gauged on potential future loading in order to meet the latest legislative criteria and customer needs as appropriate.

The information in this sales literature is by necessity, brief. For further technical literature or assistance on sizing please contact Klargester.

Blower Kiosk

To enable rapid installation, Klargester supply a range of prefabricated GRP kiosks to house the blower units. Discreet and acoustically-lined, the kiosks feature venting, ground anchorage and lockable doors.

Air Blower

An alternative to the standard location, safe and secure.

Control

The control panel is located inside the kiosk.

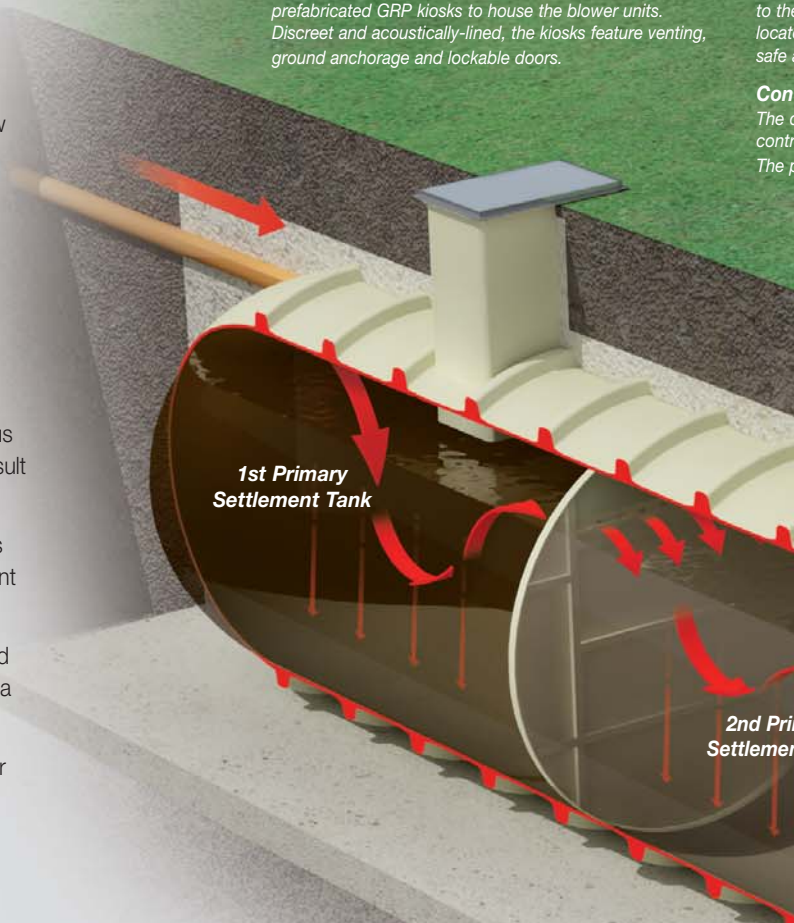

Biotec™ 7 Technical Specification

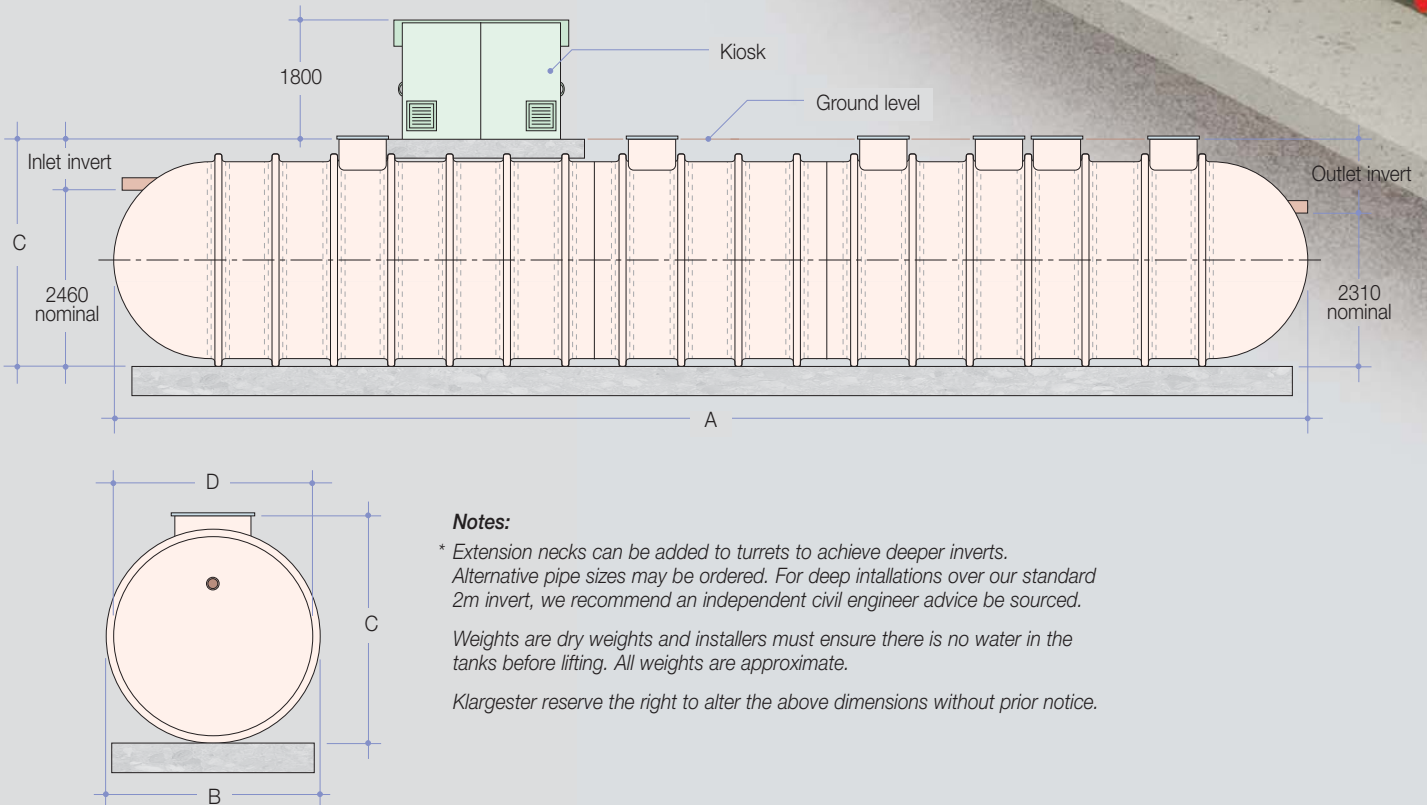

Notes:

* Extension necks can be added to turrets to achieve deeper inverts. Alternative pipe sizes may be ordered. For deep installations over our standard 2m invert, we recommend an independent civil engineer advice be sourced.

Weights are dry weights and installers must ensure there is no water in the tanks before lifting. All weights are approximate.

Klargester reserve the right to alter the above dimensions without prior notice.

Blower

Above ground blower supplies pumped air to submerged air diffusers. The blower is housed within the kiosk providing simple and easy access for routine maintenance.

Control Panel

The control panel automatically monitors and controls the operation of the Biotec™ plant. The panel can be mounted externally.

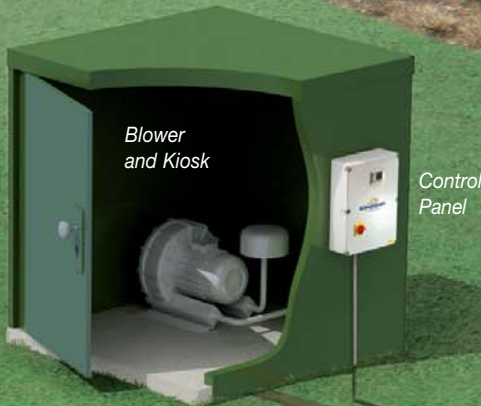

Blower and Kiosk

Control Panel

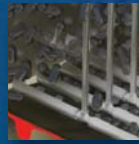

Air Diffusers

Pumped air diffusers supply oxygen to the bacteria growing on the surface of the media. Aeration also optimises the treatment process by scouring away excess biomass.



Integral Flow Management

Biotec™ features internal volume balancing to counteract surges in influent and periods of low flow. This avoids the detrimental effects on process performance caused by variable and shock loads.

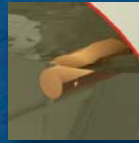

Submerged Scum Baffle

The submerged baffle design prevents floating fine particles from exiting the plant, retaining scum within the final settlement chamber.

Primary Settlement Tank

Biozone

Biozone

Final Settlement Tank

Biotec™ Model	7
A Overall Length (m)	7.4
B Overall Width (m)	2.8
C Height (m)	
500mm Inlet / 650mm Outlet Invert*	3.0
1000mm Inlet / 1150mm Outlet Invert*	3.5
1500mm Inlet / 1650mm Outlet Invert*	4.0
2000mm Inlet / 2150mm Outlet Invert*	4.5
D Diameter (m)	2.6
Volume (m³)	34
Weight approx (kg)	3000
Inlet / Outlet Diameter (mm)	160
Maximum flow (m³/day)	17
Retention time (hrs)	45

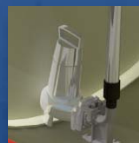

Sludge Return

Surplus biomass is recirculated into the primary settlement chamber by a timer controlled pump. Here it is co-settled with the main sludge residue.

Klargester Biotec™ 5-6

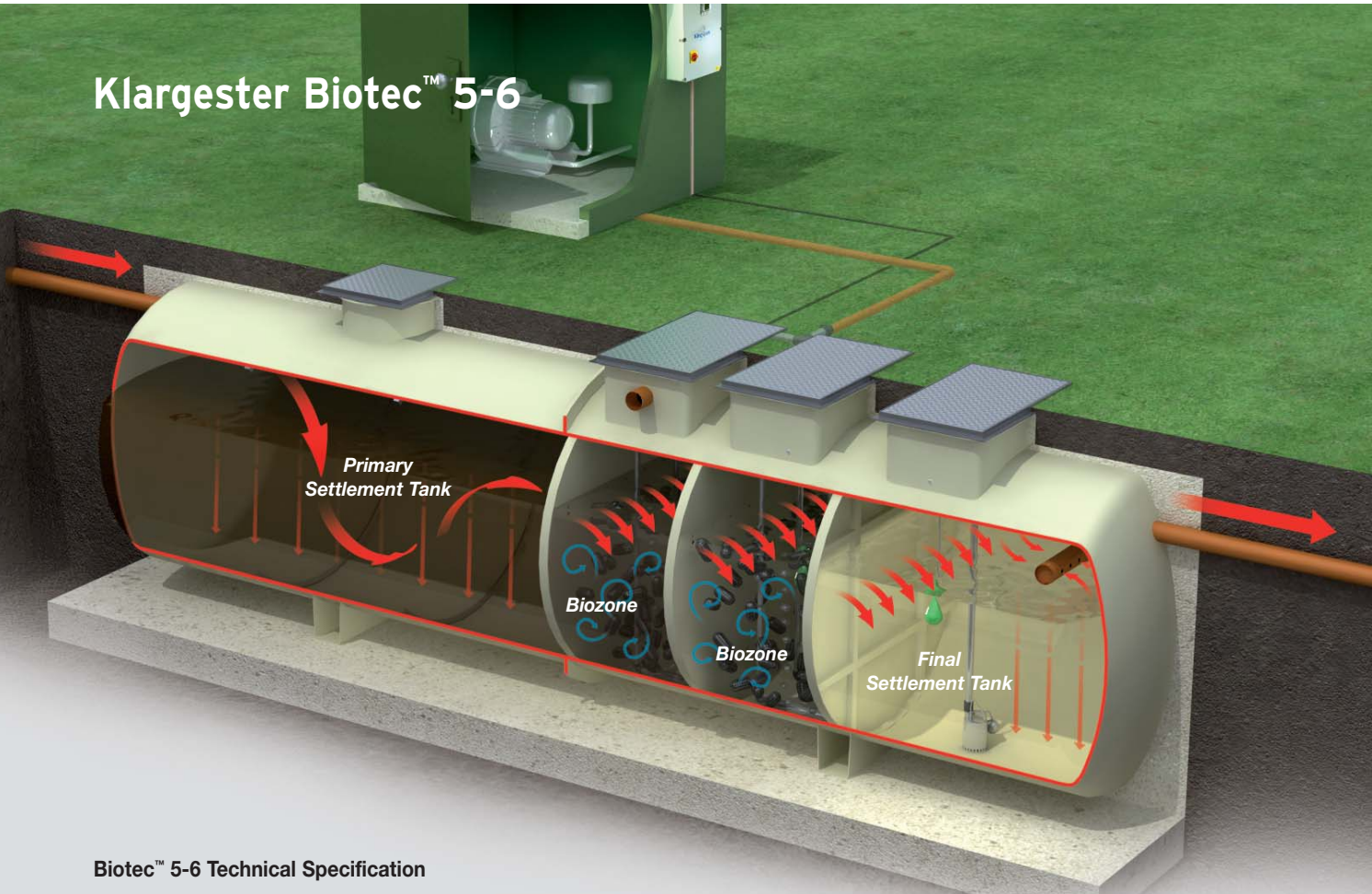

Biotec™ 5-6 Technical Specification

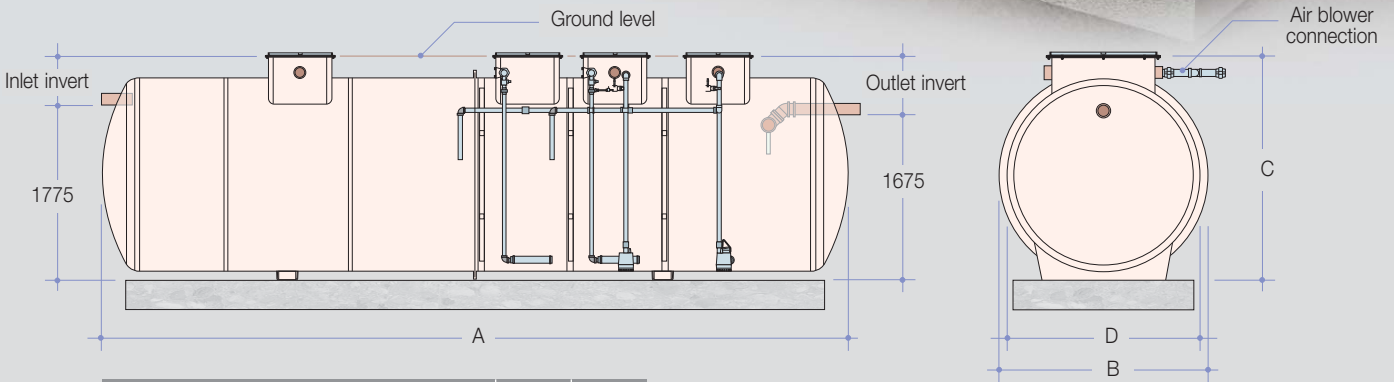

Biotec™ Model	5	6
A Overall Length (m)	7.20	9.40
B Overall Width (m)	2.02	
C Height (m)		
500mm Inlet / 600mm Outlet Invert*	2.25	
1000mm Inlet / 1100mm Outlet Invert*	2.75	
1500mm Inlet / 1600mm Outlet Invert*	3.25	
2000mm Inlet / 2100mm Outlet Invert*	3.75	
D Diameter (m)	1.87	
Volume (m ³)	19	25
Weight approx (kg)	1200	1450
Inlet / Outlet Diameter (mm)	110	
Maximum flow (m ³ /day)	8	11
Retention time (hrs)	51	47

Notes:

* Extension necks can be added to turrets to achieve deeper inverts. Alternative pipe sizes may be ordered. For any deep installation above our standard 2m invert, we recommend independent civil engineer advice be sourced.

Weights are dry weights and installers must ensure there is no water in the tanks before lifting. All weights are approximate.

Klargester reserve the right to alter the above dimensions without prior notice.

The Market Leading Range of Klargester Sewage Treatment, Pumping and Drainage Solutions from Kingspan Environmental

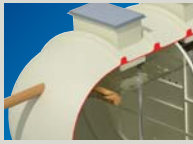

Commercial Sewage Treatment Plants



Large Capacity Pumping Stations

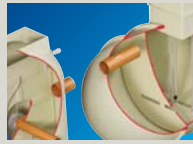

Stormwater Attenuation Systems



Domestic Sewage Treatment Plants



Packaged Pump Systems



Reed Beds

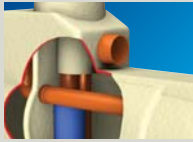

Oil/Water Separators



Septic Tanks



Below Ground Storage Tanks

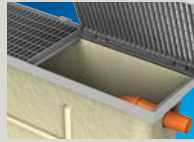

Grease & Silt Traps



Packaged Drainage Systems

KingspanWater Rainwater Harvesting Solutions



Residential & Commercial Rainwater Harvesting



Domestic Rainwater Harvesting

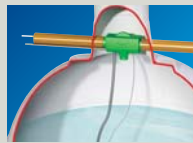

Garden Watering Systems

Kingspan Environmental Accredited Installers

Strategically located throughout the UK and Ireland, Kingspan Environmental Accredited Installers are appointed following a selection process which assesses their installation expertise, reputation and financial status.

These performance criteria, together with their design skills and knowledge of Kingspan Environmental products are also reviewed to ensure that the highest levels of professionalism are maintained.



Free Site Visit

To help determine your exact requirements, Klargester offer free site visit support from our team of specialist Area Sales Managers. Please call, fax or click for more information.

Kingspan Environmental Service

Who better to look after your treatment plant than the people who designed and built it?

Kingspan Environmental have a dedicated service division providing maintenance for wastewater treatment products.

Factory trained engineers are available for site visits as part of a planned maintenance contract or on a one-off call out basis.

To find out more about protecting your investment and ensuring peace of mind, contact us on **0845 355 0555** or visit us online at

www.kingspanenvservice.com



Accredited to
BS EN ISO 9001: 2008
BS OHSAS 18001: 2007



Issue No. 3: August 2010



UK: College Road North, Aston Clinton, Aylesbury, Buckinghamshire HP22 5EW
Tel: +44 (0) 1296 633000 Fax: +44 (0) 1296 633001
Scottish Office: Tel: +44 (0) 1355 248484
email: info@klargester.com

Ireland: Unit 1a, Derryboy Road, Carnbane Business Park, Newry, Co. Down BT35 6QH
NI Tel : +44 (0) 28 302 66799 Fax: +44 (0) 28 302 60046 ROI Tel: 048 302 66799 Fax: 048 302 60046
email: info@klargester.ie

Visit our website www.klargester.com, or our company website www.kingspanenv.com

